

OPTONICA

USER MANUAL - LED FAN CEILING

SKU: 19113, 19114

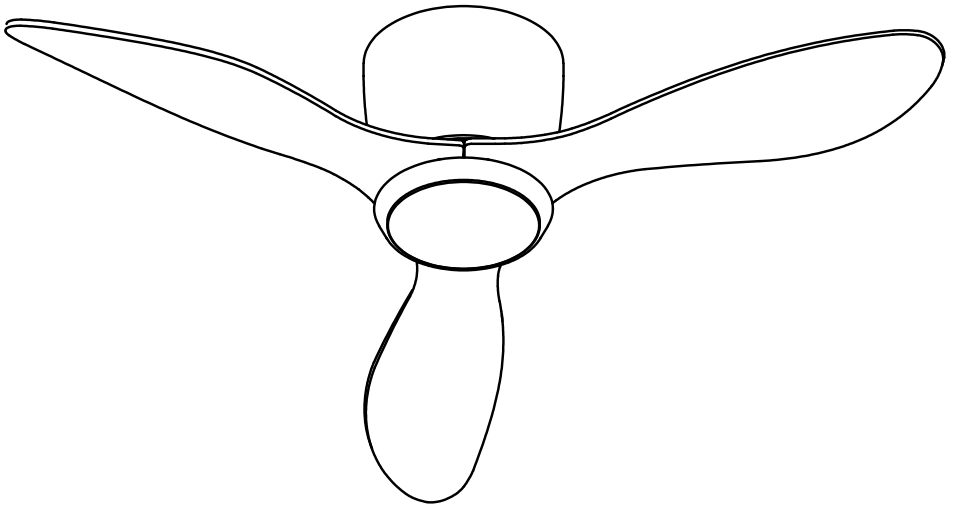

Packing List

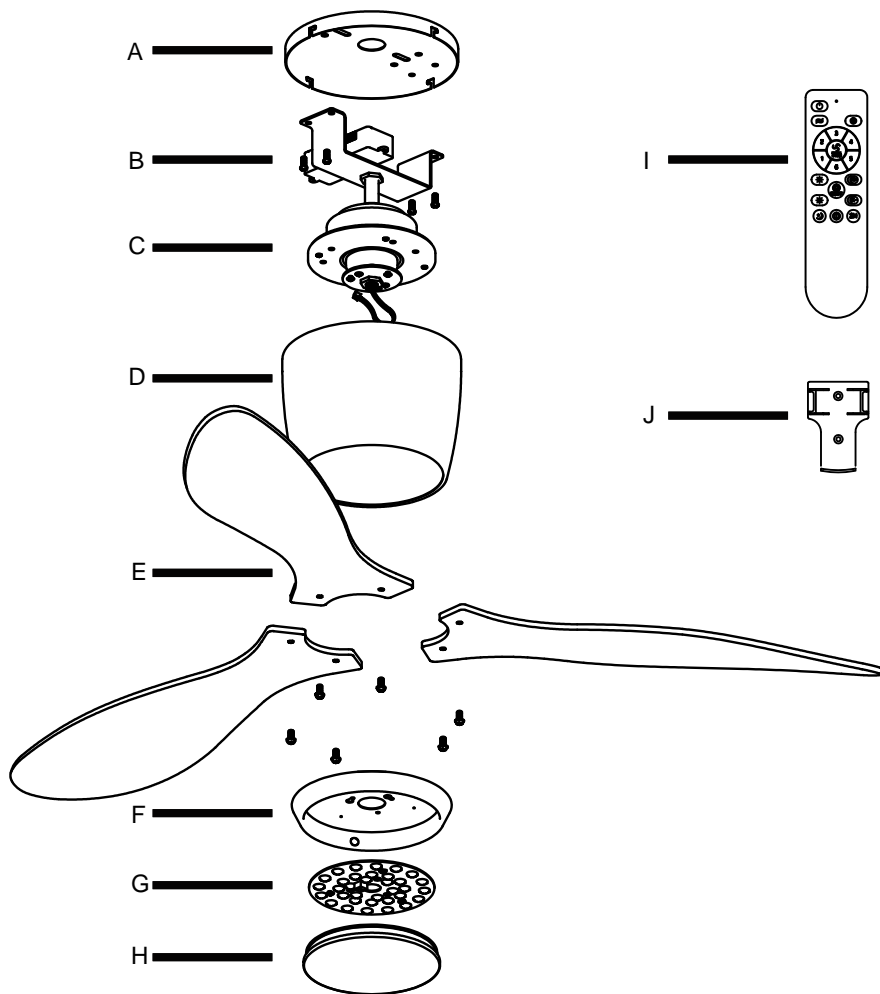

Part	Description	Quantity
A	Mounting Bracket	1
B	Driver	1
C	DC Motor	1
D	Motor Cover	1
E	Fan blade	3

Part	Description	Quantity
F	Iron basin	1
G	LED light	1
H	Lamp shade	1
I	Remote Control	1
J	Remote Holder	1

Installation kit

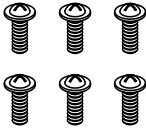

AA

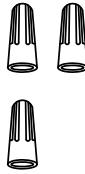

BB



CC



DD

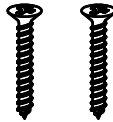

EE

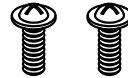

FF

Part	Description	Quantity
AA	Fan blade Screw	6
BB	Wire nut	3
CC	Pair of Gloves	1
DD	Washer	2
EE	Wood Screw (optional)	2
FF	Machine Screw	2

Note:

Some extra hardware may be included. The quantity listed above is the number required for installation.

Safety Rules

1. Be sure the power to the wires you are working on is disconnected, either the fuse is removed or the circuit breaker is turned off. Turning the power off using the light switch is not sufficient to prevent electrical shock.
2. A qualified licensed electrician is required for the installation.
3. The outlet box and support structure must be securely mounted and capable of reliably /supporting a minimum of 50 pounds. Use only UL (cUL for Canadian Installation) listed mounting boxes marked "FOR FAN SUPPORT".
4. The fan must be mounted with a minimum of 7 feet clearance from the trailing edge of the blades to the floor.
5. Do not operate reversing switch while fan blades are in motion (if applicable). Fan must be turned off and blades stopped before reversing blade direction.
6. Do not place any objects in the path of the blades.
7. To avoid personal injury or damage to the fan and other items, be cautious when working around or cleaning the fan.
8. Do not use water or detergents when cleaning the fan or fan blades. A dry dust cloth or lightly dampened soft cloth will be suitable for the cleaning.
9. After marking electrical connections, spliced conductors should be turned upward and pushed carefully up into outlet box. The wires should be spread apart with the grounded conductor on one side of the outlet box.
10. Electrical diagrams are reference only, different fan light may have different light shade and bulbs.
11. Use only our replacement parts. This equipment has been tested and found to comply with the limits for a class B digital device, pursuant to part 15 of the FCC Rules. These limits are to provide reasonable protection against harmful interference in a residential installation. This equipment generates, uses and can radiate radio frequency energy and if not installed and used in accordance with the instructions may cause harmful interference to radio communications.

Warning:

To reduce the risk of personal injury, use only the two steel screws and washers provided with the outlet box for mounting to the outlet box. Most outlet boxes commonly used for the support of lighting fixtures are not acceptable for fan support and need to be replaced, consult a qualified electrician if in doubt.

To reduce the risk of fire, electric shock or person injury, mount fan to outlet box marked "acceptable for fan support".

To reduce the risk of personal injury, do not bend the blade brackets (also referred to as flanges) during assembly or after installation. Do not insert objects in the path of the blades.

Installation Preparation

Tools You Need

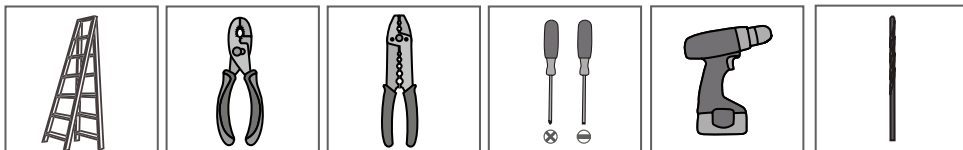

- Ladder Pliers Wire Strippers Screwdrivers Power Drill (optional) Drill Bit (optional)

If mounting to a support structure, you will also need the optional tools.

What to Expect with Your Installation

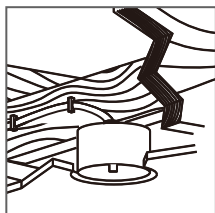

- Must be able to secure the fan to building structure or fan-rated outlet box

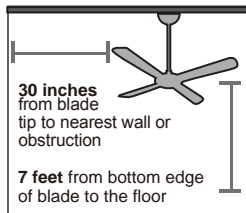

- Assess location



- Check box to see fan weight



- Angled Ceiling not supported

Installation Step 1 (Mount and Wire)

1. Installing the Bracket

Step 1. Pass the power wires through the center hole in the mounting bracket.

Step 2. Secure the mounting bracket to the ceiling outlet box or solid wood structure with the screws and washers provided.

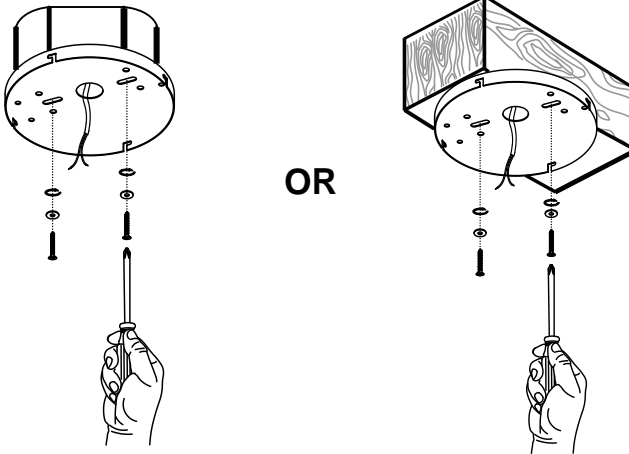

2. Installing the Motor

Step 1. Fix the motor to the bracket using the fixing screws.

Step 2. Connect the wires from the fixture to the house supply wires with wire nuts, ground wire (green, green/yellow, or bare copper) to ground wire, neutral wire (white or blue) to neutral wire, and hot wire (black or brown) to the hot wire. Wrap the connection with electrical tape.

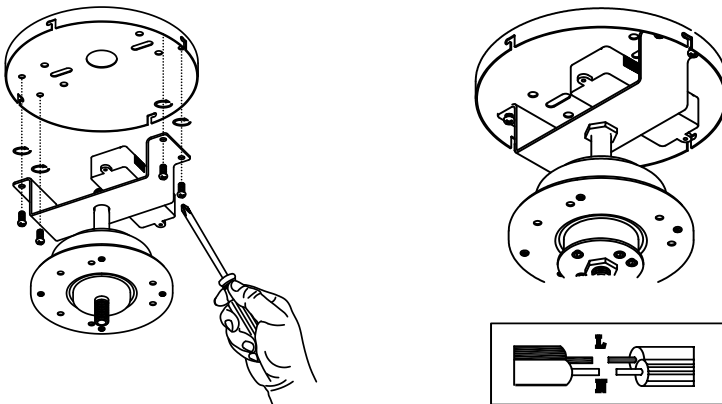

Installation Step 2 (Assemble the Cover and Blades)

3. Fix the Motor Cover

Step 1. Use the Motor Cover to cover the Bracket as indicated by the arrow.

Step 2. Rotate the motor cover clockwise and lock it.

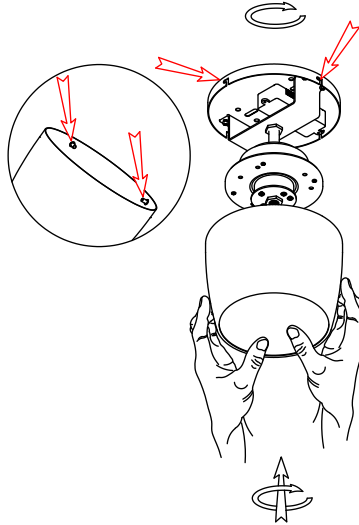

4. Assemble the Blades

Step 1. Connect the fan blades to the motor with screws.

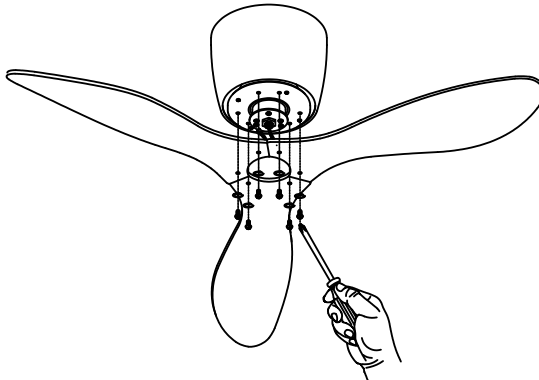

Note:

- ① Make sure to assemble the blades in sequence and fasten the screws with equal force.
- ② The fan blades have both sides, please follow the instructions on the fan blades for installation.

Installation Step 3 (Fix the LED Panel)

5. Install and Wire the Light

Step 1. Install the lamp panel and lamp shade in the order of disassembly.

Step 2. Connect the wire terminal to the interface on the light panel.

Step 3. Rotate the lampshade clockwise to secure it to the lamp panel.

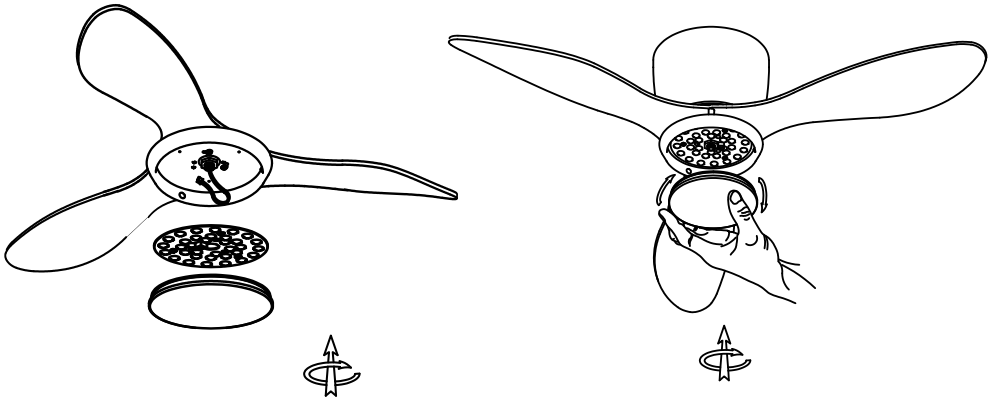

Installation Step 4 (Install the Remote Holder)

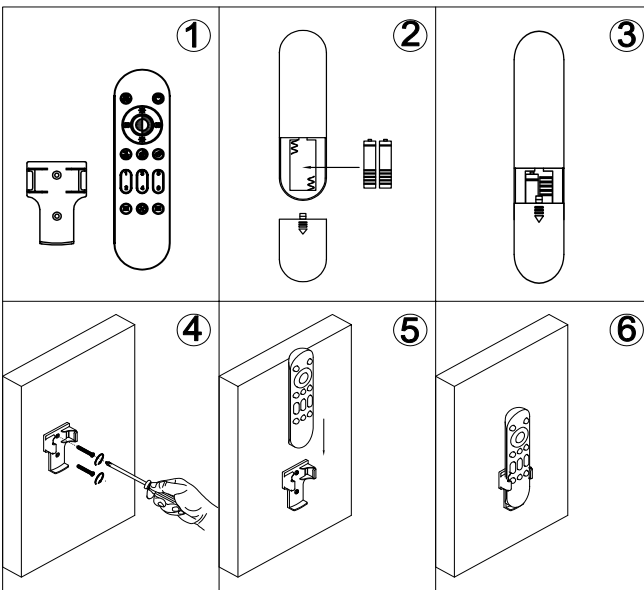

1. Insert 2 batteries before using:

AAA 1.5V battery x 2pcs
(not included)

2. Install the remote holder
onto the wall with screws.

Remote Control Instructions

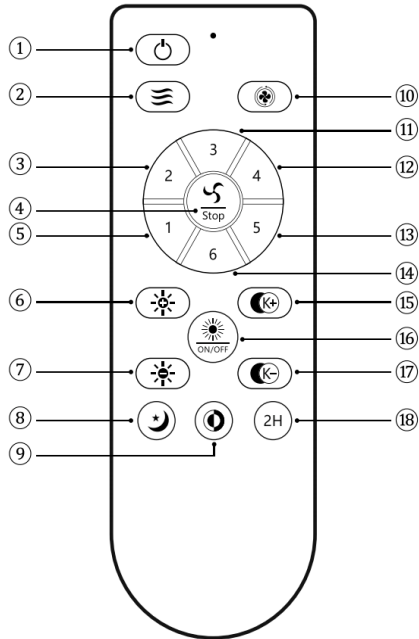









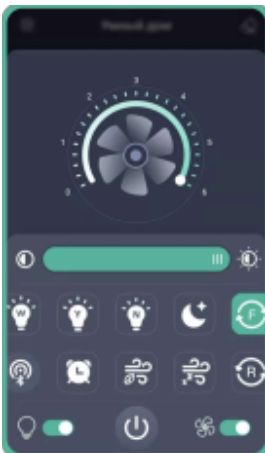
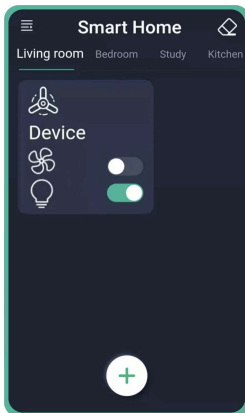







- ①: Turn off power.
- ②: Natural wind, fan speed will change automatically with this function.
- ③⑤⑪⑫⑬⑭: Turn on the fan on 1/2/3/4/5/6 speed.
- ④: Turn off the fan.
- ⑩: Fan moves forwards or reversely.
- ⑥⑦: Adjust the brightness of the light.
- ⑮⑰: Adjust the light color temperature.
- ⑯: Turn on / off the light.
- ⑱: Night mode, dim the lights.
- ⑲: Quick switch of the light color: warm white→cool white→daylight white.
- ⑳: 2H for timing the fan.

REMOTE SIGNAL PAIRING: If the remote control loses signal of the fan, press and hold the button ⑯ at the very beginning after it's turned on from wall switch. After the fan light flashes or beeps, it's done

APP Control Instructions

Install the "FanLamp Pro" app from Google Play, Apple App Store, or other app stores by scanning the QR code or searching for the app name. Ensure that your phone is connected to the internet and Bluetooth enabled.



-  Pairing: Click the Pair button within 5 seconds after turning on the fan from the wall switch. Once the fan flashes or beeps, it has been successfully paired with your phone and can now be controlled through the app.
-  Slide the slider to change the fan speed.
-  Slide the slider to change the brightness of the light.
-  Quick switch for "White" light color.
-  Quick switch for "Yellow" light color.
-  Quick switch for "Natural" light color.
-  Night mode: Dim the lights.
-  Fan moves forward.
-  Change the direction of the wind (Not applicable on this fan).
-  Timing the fan.
-  Natural wind: The fan speed will change automatically when you use this function.
-  Sleeping wind (Not applicable on this fan).
-  Fan moves reversely.
-  Turn on/off the light.
-  Turn on/off the fan.
-  Unpairing: Click the Unpair button within 5 seconds after turning on the fan. Once the fan flashes or beeps, it has been successfully unpaired from your phone.

Trouble Shooting

1. Fan doesn't work

- Make sure the fixture is connected to an ON/OFF wall switch, not dimmer switch.
- Check the remote control battery (not included in this package).
- Check the circuit breaker to ensure the power is on.
- Turn off power from the circuit breaker, then loosen the canopy and check all the connections according to the wiring diagram.

2. Lights Do Not Light Up / Flicker / Noisy Operation

- Make sure the fixture is connected to an ON/OFF wall switch, not dimmer switch.
- Check your power and switch to make sure it's power on.

3. Noisy Operation

- Re-tighten all screws on bracket.
- Check to see if any of the blades are cracked. If so, replace the blades.

4. Remote does not work

- Make sure the battery is installed correctly.
- Pair the remote control again (See page 9).
- Install 2 new batteries.

Clean And Care

To clean, wipe the fixture with soft cloth. Spray from chemical cleaners can discolor the finish of the fixture. Do not use scouring pads, powders, steel wool or abrasive paper to clean this fixture.

Ordering Parts

Keep this manual for future reference, and in case replacement parts are needed. Available parts can be ordered from place of purchase. Use exact wording from diagrams when ordering parts.