

OPTONICA

LED Влагозащитено Тяло

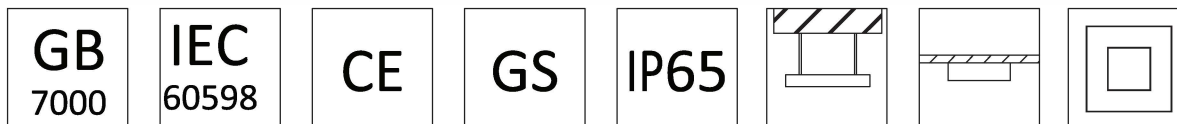

Вид	Волтаж/Честота	Ват (W)	Лумени (lm)	CRI	L (mm)	W (mm)	H (mm)	LF (mm)
40W Тяло	220-240V/50-60Hz	40	4400	≥80	1186	70	60	800
55W Тяло	220-240V/50-60Hz	55	6000	≥80	1486	70	60	1100

SKU: 6701-6712 / 16701-16712 - свързващи се

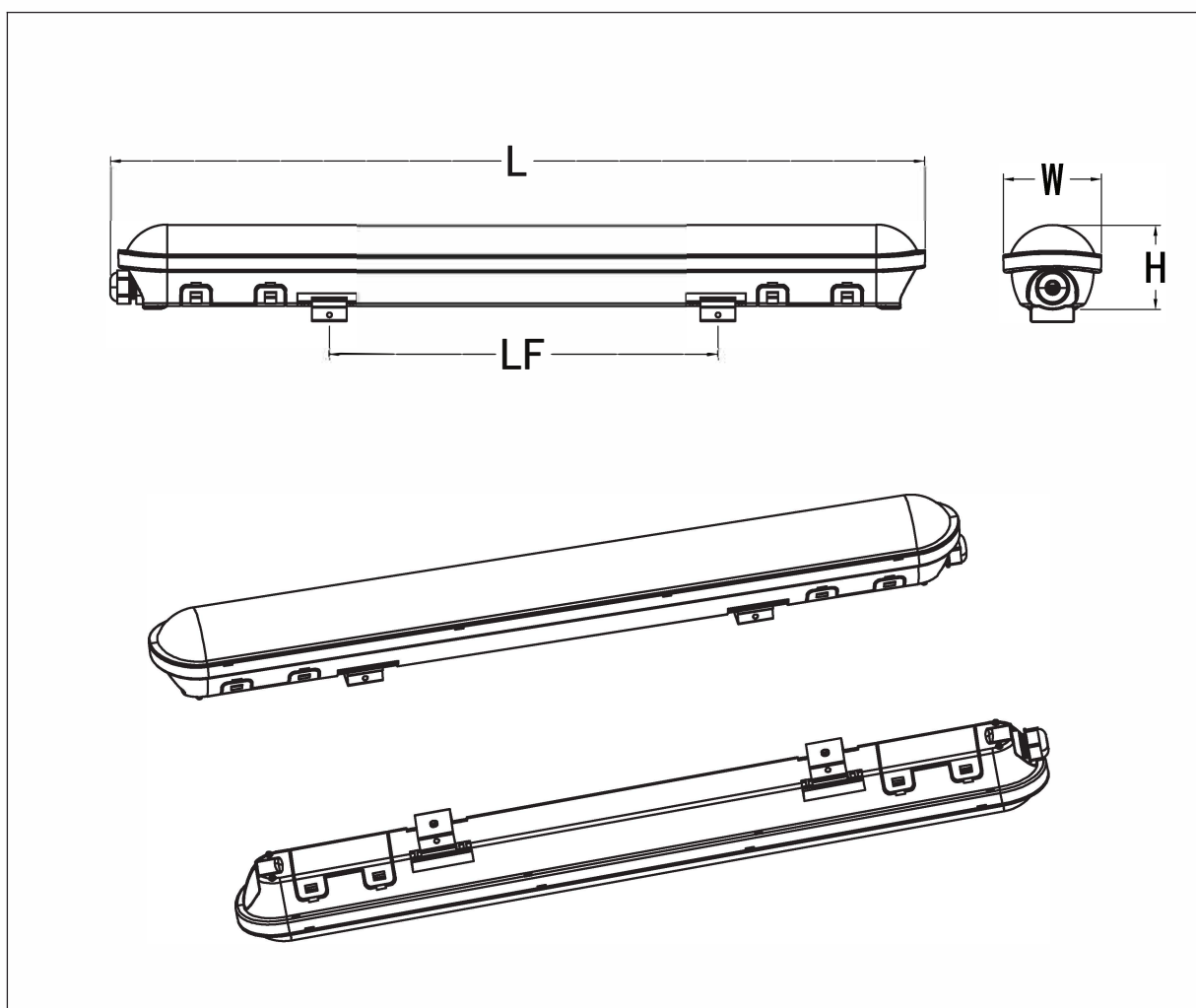

Инсталация

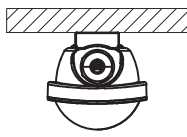

Монтаж в/у
повърхности



Окачен Монтаж

1

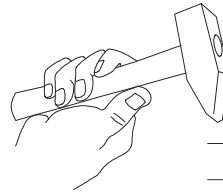
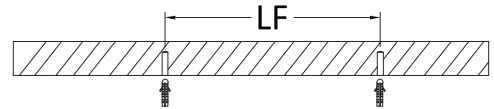

Вид	LF (mm)
40W	800
55W	1100

2

Монтаж в/у повърхности

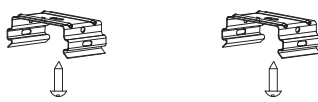
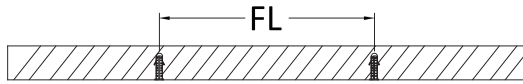

Инсталационен винт ST4.2 X 30

Окачен Монтаж

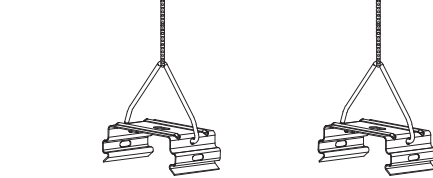
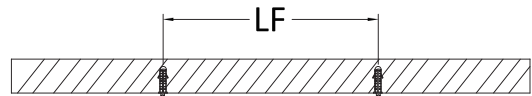

Автогамно висящо въже

3

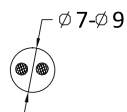
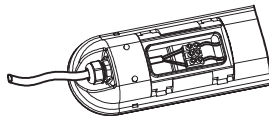
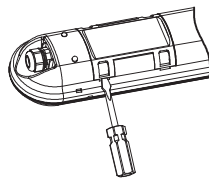

Извън диаметъра на свързващия проводник се прилага:
2G1.0mm² -2G2.0mm²

4

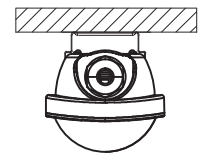
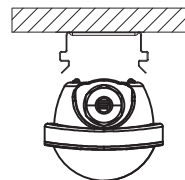

Натиснете



1. Осветителното тяло трябва да бъде инсталирано от квалифициран електротехник, свързано спрямо последните изискванията на IEE и националните препоръки.
2. Не включвайте захранването преди да завършите инсталацията.
3. Осветителното тяло не трябва да бъде покривано.

OPTONICA

LED Wannenleuchte IP65



Type	Spannung/Hz	Pmax (W)	Lumen	CRI	L (mm)	B (mm)	H (mm)	LF (mm)
40W Fixture	220-240V/50-60Hz	40	4400	≥80	1186	70	60	800
55W Fixture	220-240V/50-60Hz	55	6000	≥80	1486	70	60	1100

SKU: 6701-6712 / 16701-16712 - verbundene

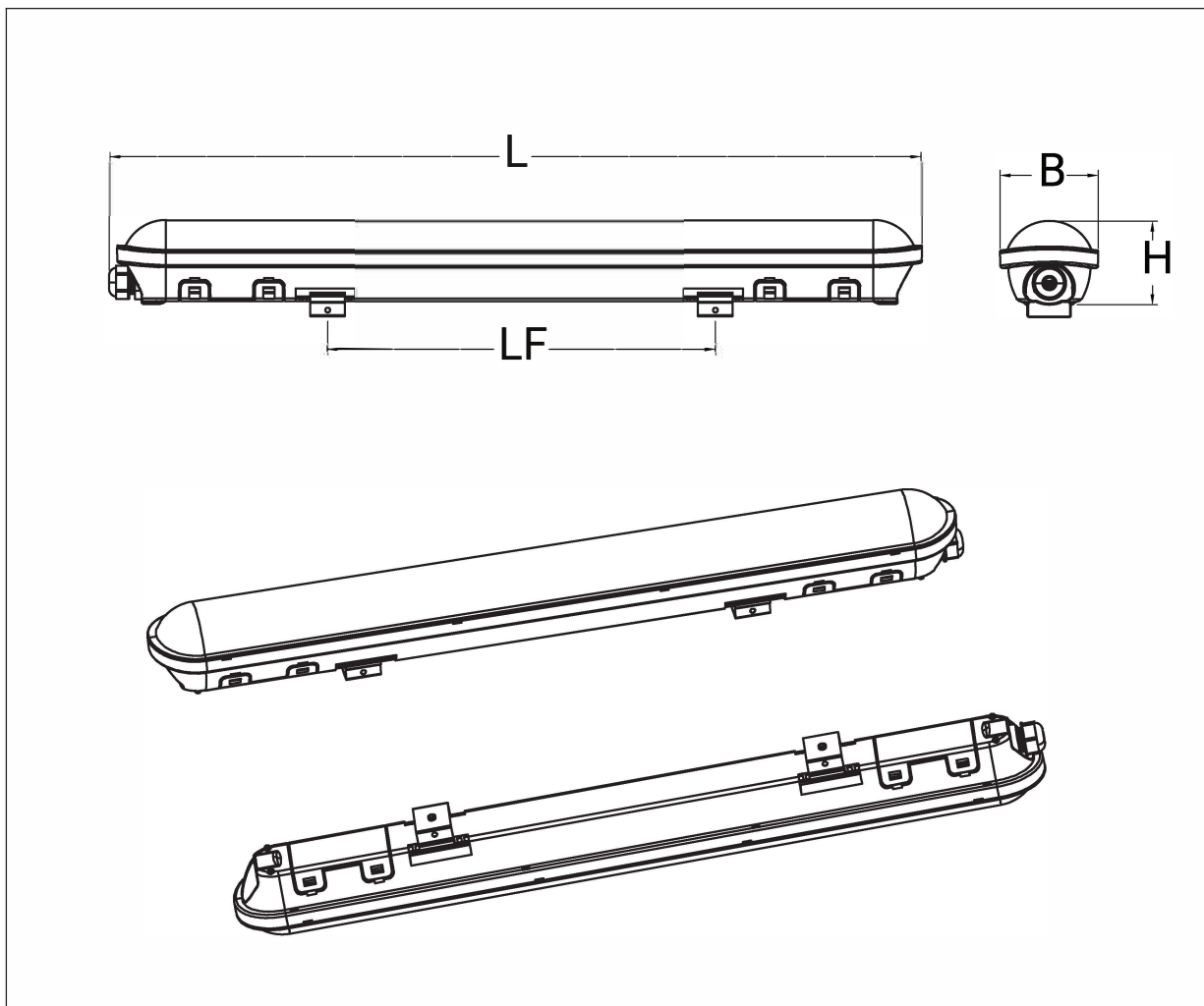

Installation

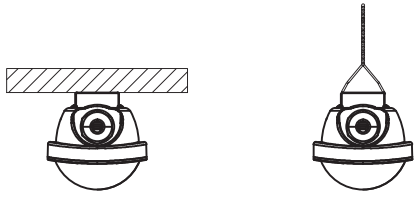

Aufputzmontage abgehängte Montage

1

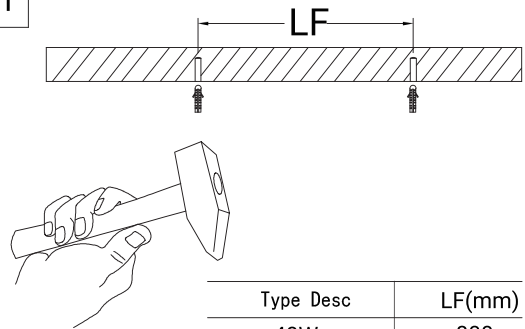

Type Desc	LF(mm)
40W	800
55W	1100

2

Aufputzmontage

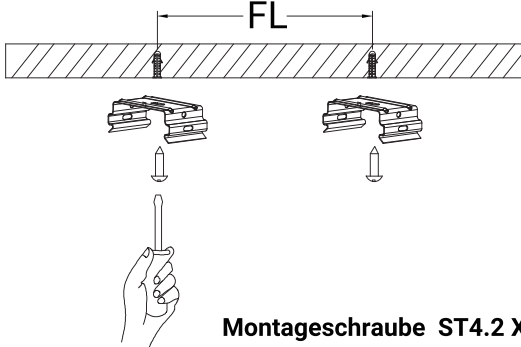

Montageschraube ST4.2 X 30

abgehängte Montage

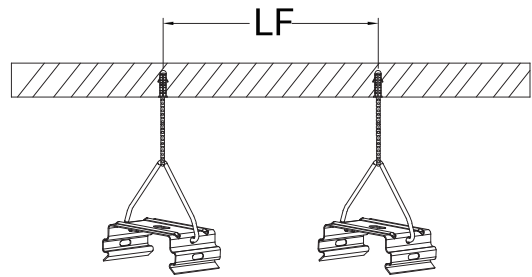

3

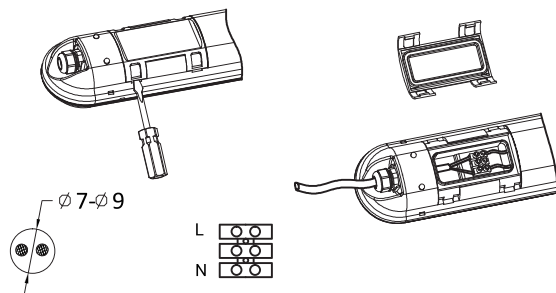

empfohlener Kabelquerschnitt: 2xG1.00mm²-2xG2.00mm²

4

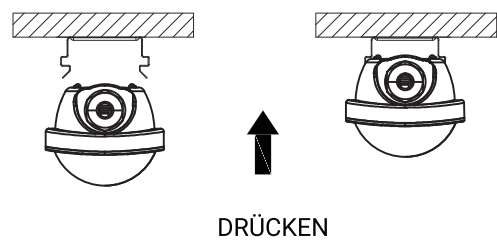

1. Die Leuchte muss von einem qualifizierten Elektriker installiert und gemäß den neuesten IEE-Elektrovorschriften oder den nationalen Anforderungen verkabelt werden.

2. Nicht einschalten, bevor die Installation abgeschlossen ist.

3. Die Leuchte darf auf keinen Fall mit isolierenden Materialien abgedeckt werden.

OPTONICA

LED Waterproof Fixture



Type Desc	Voltage/Frequency	Pmax (W)	Luminous flux (lm)	CRI	L (mm)	W (mm)	H (mm)	LF (mm)
40W Fixture	220-240V/50-60Hz	40	4400	≥80	1186	70	60	800
55W Fixture	220-240V/50-60Hz	55	6000	≥80	1486	70	60	1100

SKU: 6701-6712 / 16701-16712 - linkable

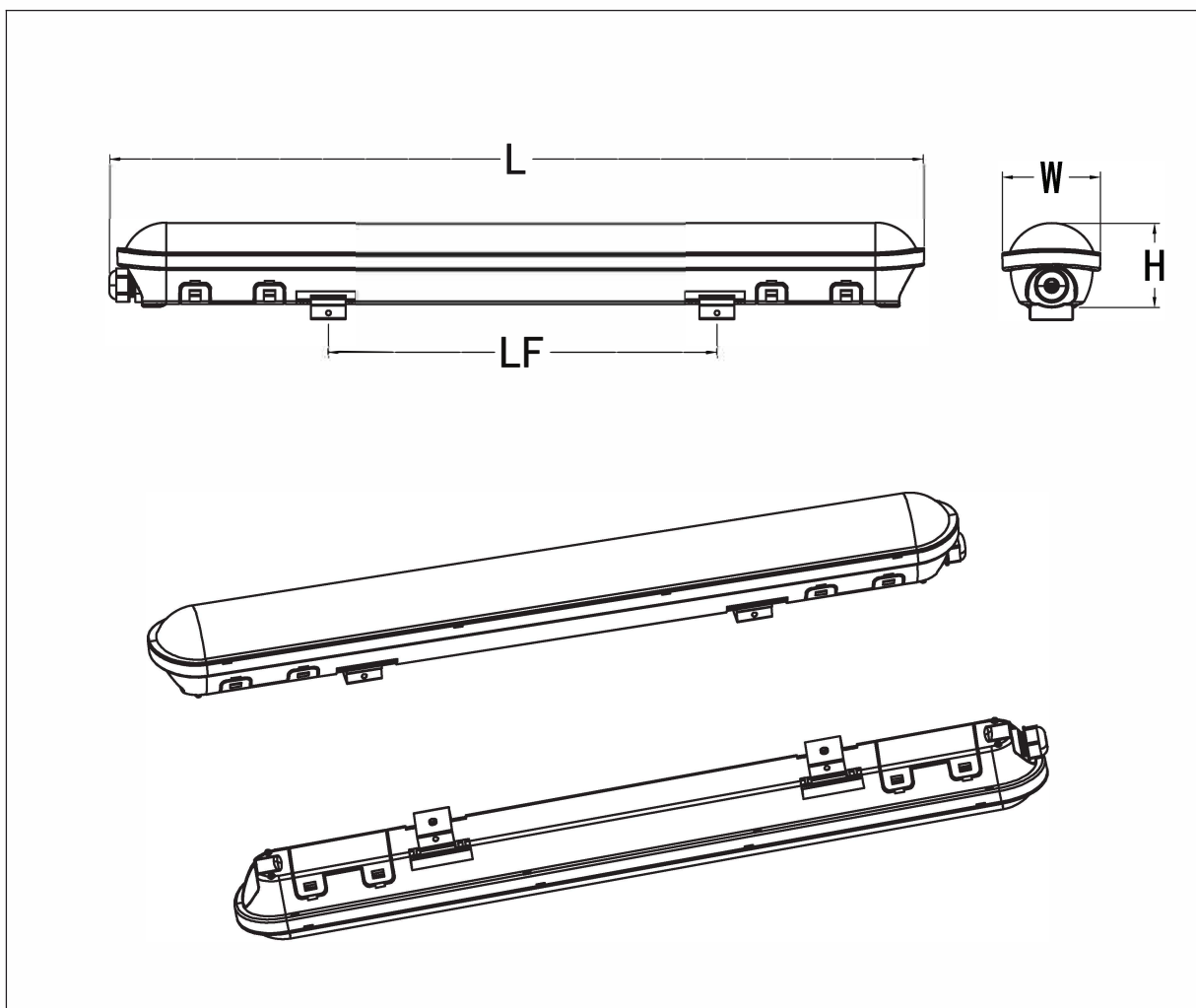

Installation

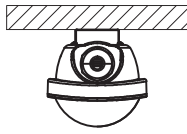

Surface Mounting



Suspension Mounting

1

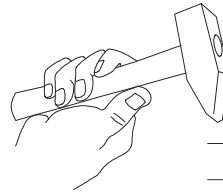
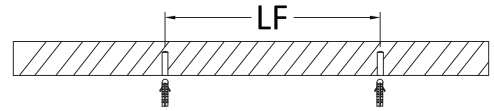

Type Desc	LF (mm)
40W	800
55W	1100

2

Surface Mounting

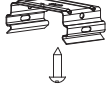
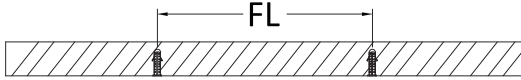

Installation screw **ST4.2 X 30**

Suspension Mounting

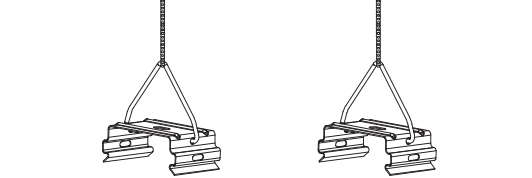
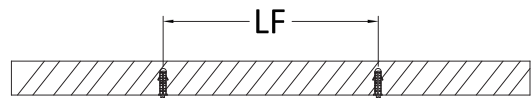

Autogamy hanging rope

3

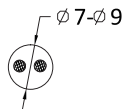
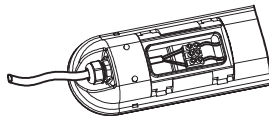
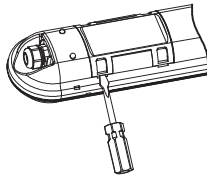

L 
N 

Outside the connection wire diameter shall apply : 2G1.0mm²~2G2.0mm²

4

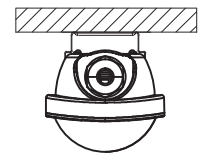
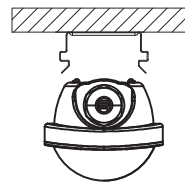

PUSH

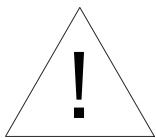

1. The luminaire shall be installed by a qualified electrician and wired in accordance with the latest IEE electrical regulations or the national requirements
2. Do not switch on before complete installation
3. The luminaire shall, under no circumstance, be covered with insulation matting or similar material.