

OPTONICA

USER MANUAL

LED STREET LIGHT

Please take time to read this leaflet carefully and retain it for future reference.

DIAGRAM

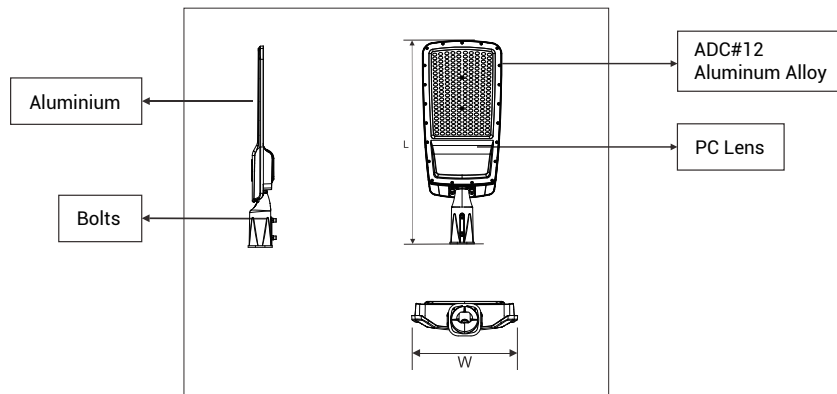

IMPORTANT SAFETY INFORMATION

- Do not wire this floodlight into the lighting circuit - use a switched fused spur.
- Before installation and servicing disconnect the electrical supply at the mains.
- Carefully observe all instructions or warnings that are labelled on, or supplied with your product.
- This product is suitable for outdoor use. If in any doubt, consult a qualified electrician.

FIXING INSTRUCTIONS

Do not wire this floodlight into the lighting circuit - use a switched fused spur. This fitting must be earthed, contact a qualified electrician to install a suitable earth facility. Ensure the electricity is turned off at the mains before installing or maintaining any electrical fitting.

NOTE

For new installations, check for any electrical cables or pipe work (gas/water) in the vicinity of the intended mounting point for this product, before proceeding with the installation.

GENERAL INFORMATION

Do not mount ceiling/wall fittings onto damp surfaces such as newly painted or pleastered areas as this may cause discolouration of the finish.

Tools which may be required:

- Drill
- Cross Head Screwdriver
- Small Electrical Slotted Screwdriver
- Insulation Tape

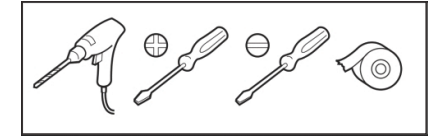

INSTALLATION

Note: before installation.

Only use a round cable supplied to connect this fitting. (6mm Diameter minimum.)

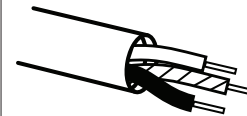

This is required in order to create a good water seal when connected to the fitting.

1. Fasten the adjustable bracket with stainless steel screws.

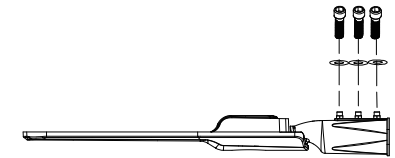

2. Connect the Main Line to the power wire of the lamp

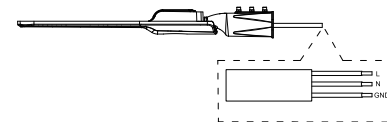

3. Ensure the terminal connection is made inside a suitable IP65 rated junction box. (not included)

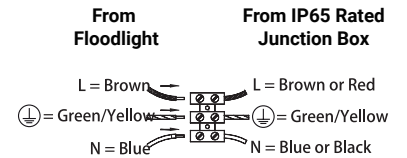

4. Install the LED street lights in the pole and wall.

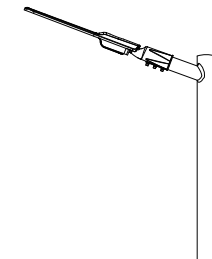

This product should be disposed of responsibly at the end of its life. Please recycle where facilities exist. (Waste Electrical and Electronic Equipment Directive)