

OPTONICA

Industrial LED High Bay light

Please take time to read this leaflet carefully and retain it for future reference.

Diagram:

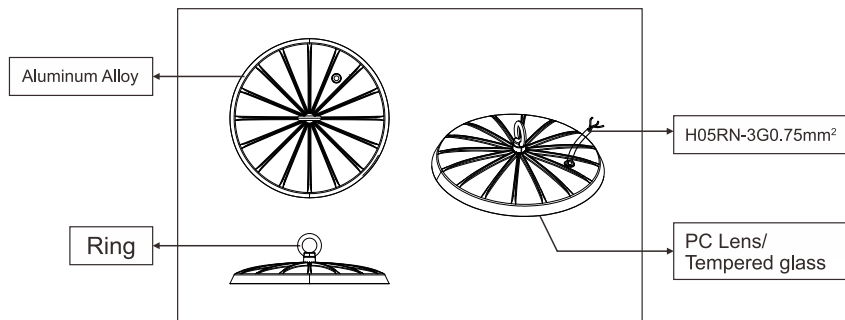

Important Safety Information

Do not wire this lantern into the lighting circuit - use a switched fuse spur.
Before installation and servicing, disconnect the electrical supply at the mains.
Carefully observe all instructions or warnings that are labelled on, or supplied with, your product.
This product is suitable for industrial use. If in any doubt, consult a qualified electrician.

General Information

Do not mount ceiling/wall fittings onto damp surfaces such as newly painted or plastered areas as this may cause discolouration of the finish.

Tools which may be required:

- Drill
- Cross Head Screwdriver
- Small Electrical Slotted Screwdriver
- Insulation Tape

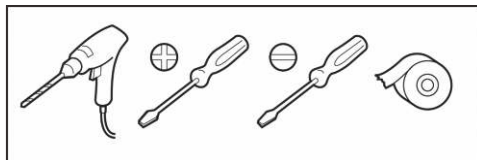

Fixing instructions

Do not wire this lantern into the lighting circuit - use a switched fuse spur.
This fitting must be earthed. contact a qualified electrician to install a suitable earth facility.
Ensure the electricity is turned off at the mains before installing or maintaining any electrical fitting.
Please note: For new installations, check for any electrical cables or pipe work (gas/water) in the vicinity of the intended mounting point for this product, before proceeding with the installation.

Installation:

Note: before installation.

Only use a **round cable supplied** to connect this fitting. (6mm Diameter minimum.)

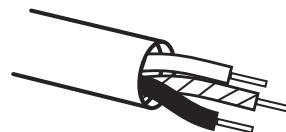

This is required in order to create a good water seal when connected to the fitting.

1-Install the ring with the light body.

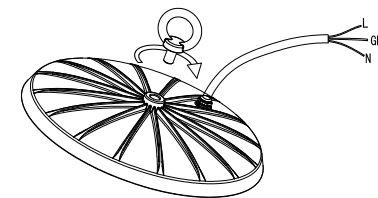

2-Connect the Main Line to the power wire of the lamp.

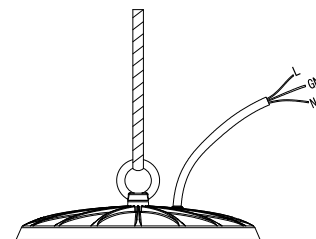

3-Ensure the terminal connection is made inside a suitable IP65 rated junction box.(not included)

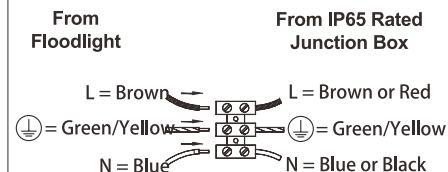

4-Install the LED High bay lights on the roof ,ceiling.

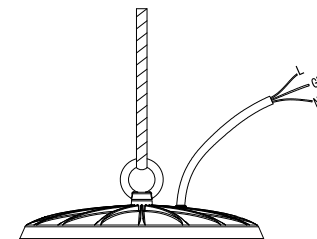

This product should be disposed of responsibly at the end of its life. Please recycle where facilities exist. Check with your Local Authority or retailer for recycling advice (Waste Electrical and Electronic Equipment Directive)